

# TIME CONTROL

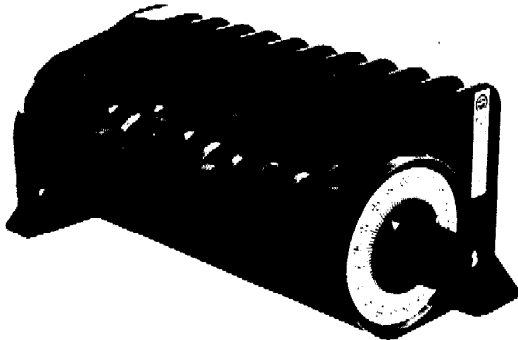

## TM SERIES TIME/MODULE® REPEAT CYCLE TIMER



The TM Series TIME/MODULE® consists of a series of modules, each interlocking with the other and keyed so they can be assembled only one way. Choosing the correct combination of modules will solve virtually all repeating time control problems. Standard units are available with one through ten switches.

There are six modules available, each distinctive in its separate function. They include a motor module with clutch, dial and knob module, a 10-1 reduction module and three different switch modules, as follows: one rise and drop tab with latch actuator (standard), two rise tabs with cam follower and two 50-50 cam segments with cam follower.

The TIME/MODULE® utilizes a unique latch switching mechanism rather than the conventional variable radius cam and follower found on most cam timers.

There are 120 serrations on the outer perimeter of the cam wheel which will accommodate a maximum of 24 tabs. A latch actuator maintains the module SPDT switch in one of its positions until a cam tab engages an actuator and triggers the switch to the opposite position. This method allows multiple switch closures on the same cam and eliminates the need for additional circuits or expensive multiple cut cams.

The TIME/MODULE® is constructed of precision molded plastic parts, using the latest injection molding techniques to provide a durable and reliable low cost cam timer. The motor and switch plates are injection molded polycarbonate to provide high impact and dielectric strength. Cams and gears are made of M<sup>3</sup>S<sup>2</sup> filled nylon to provide lifetime lubrication for all moving parts. Cam segments, cam tabs and actuators are molded of acetal for durability. All switch terminals are .187 quick disconnect type for easy connections.

## SPECIFICATIONS

### Time Ranges

SYMBOL	RANGE	SYMBOL	RANGE
01	6 Sec	13	15 Min
02	10 Sec	15	30 Min
03	15 Sec	16	60 Min
04	30 Sec	17	100 Min
05	60 Sec	18	120 Min
06	90 Sec	20	3 Hr
07	120 Sec	23	10 Hr
09	3 Min	25	30 Hr
10	5 Min	26	60 Hr
12	10 Min		

### Number of Circuits

One through ten standard

### Repeat Accuracy

Cam speed is synchronous to power supply.

### Cam Programming Accuracy

LATCH OR 50-50 CAMS

Closure time on same cam  $\pm 1\%$  of time cycle.

Closure time between two different cams  $\pm .5\%$  of time cycle.

ALL OTHER CAMS

Closure time on same cam  $\pm 1\%$  of time cycle.

Closure time between two different cams  $\pm 1\%$  of time cycle.

### Minimum Settings (average values)

Latch switching — 3% of time cycle

Cam follower with two cam tabs — 2% of time cycle

Cam follower (molded, cut, or 50-50 type) — 2% of time cycle

### Contact Rating

10 Amp, 1.3 Hp, 120-240 VAC

1.2 Amp, @120 VDC, 1.4 Amp @240 VDC

### Temperature Range

0 to 140 F (-18 to 60 C)

### Voltage/Frequency

120V (+10, -15%), 50-60 Hz

240V (+10, -15%), 50-60 Hz

### Input Burden (average values)

Standard motor — 3 Watts @ rated voltage.

### Laboratory Testing

U.L. Recognition E-61735

C.S.A. Certification LR-27967



## Eagle Signal Controls

A Division of Mark IV Industries, Inc.  
8004 Cameron Road, Austin, Texas 78753 U.S.A.

# TIME CONTROL

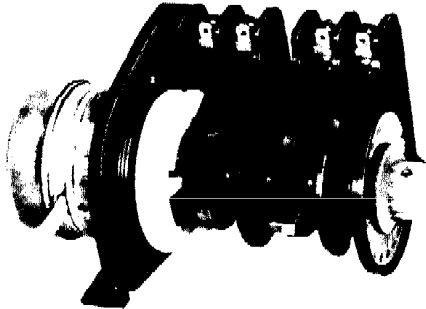

The TM Series Time/Module consists of a series of modules, each interlocking with the other and keyed so they can be assembled only one way. Choosing the correct combination of modules will solve virtually all repeating time control problems.

## PERCENTAGE DIAL & KNOB MODULE

The percentage dial added to the front of the timer provides a visual readout of program progress. The knob can be turned to manually rotate the timer through the program for troubleshooting, or as an aid in setting the cam tabs.

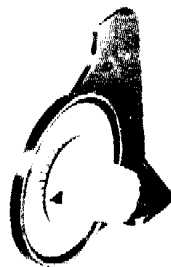

## GEAR REDUCTION MODULE

The 10:1 gear reduction module can be interchanged with any switch module. By placing the gear reduction module between circuits, more than one cycle time is available from the same motor.

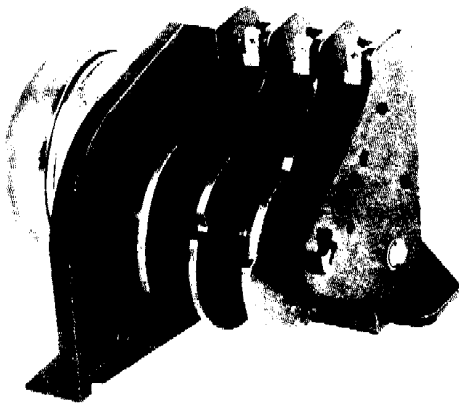

Custom molded cams are available for volume requirements. The cams are molded from permanent tooling to avoid deviation from shipment to shipment. Custom molded cams are tamper proof which is often a requirement in the presence of OSHA. Cam blanks can be cut to simulate molded cams for verification of a program or test samples.

## SWITCH MODULES

A variety of switch module types are available to meet all programming requirements. Up to ten switch modules can be used on each timer and the types can be inter-mixed to meet the program needs.

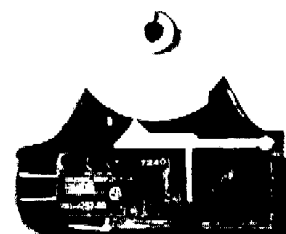
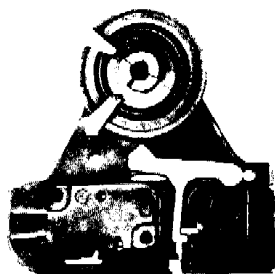

# TIME CONTROL



## MODULE KITS

The TIME/MODULE® is also available in kit form for construction to suit a wide variety of timer requirements. Ordering the modules in kit form and building a timer to suit specific requirements can be the most economical method of satisfying needs.

TM

### STANDARD SWITCH MODULE (TM-0570)

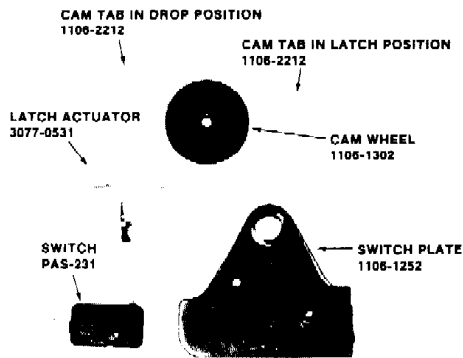

### 50-50 CAM SWITCH MODULE (TM-0580)

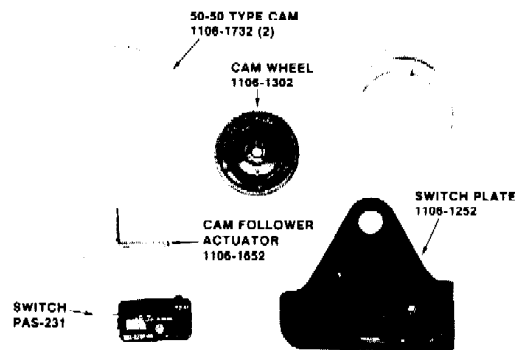

### 10:1 REDUCING MODULE (TM-0590)

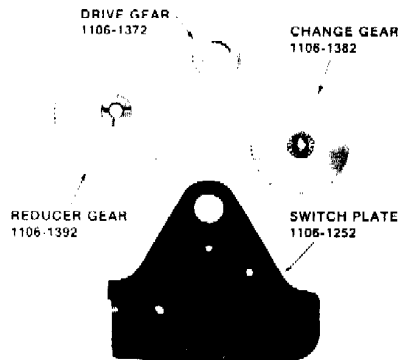

### DRIVE MODULE (TM-0600)

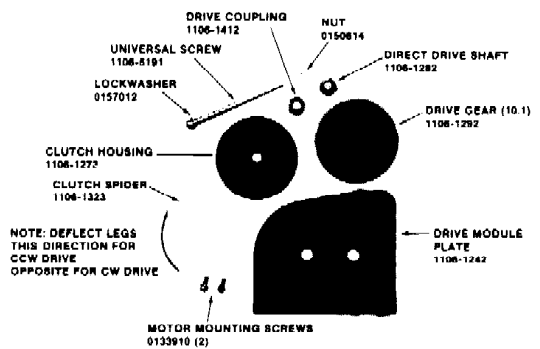

### DIAL & KNOB MODULE (TM-0290)

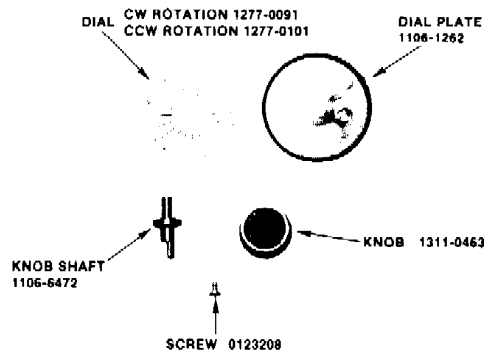

# TIME CONTROL



## MOUNTING DIMENSIONS

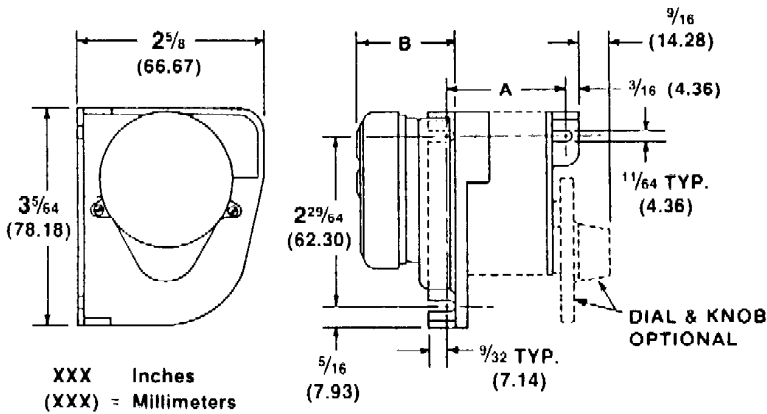

## TIME RANGE CHART

SYM.	CW Motor Speed	TIME CYCLE		CAM Shaft Rotation
		Direct Drive Motor Module	10.1 Drive Motor Module	
01	10 RPM	6 Sec		CW
02	60 RPM		10 Sec	CCW
03	40 RPM		15 Sec	CCW
04	20 RPM		30 Sec	CCW
05	10 RPM		60 Sec	CCW
06	2 3 RPM	90 Sec		CW
07	1 2 RPM	120 Sec		CW
08	4 RPM		150 Sec	CCW
09	1 3 RPM	3 Min		CW
10	2 RPM		5 Min	CCW
11	1 6 RPM	6 Min		CW
12	1 10 RPM	10 Min		CW
13	1 15 RPM	15 Min		CW
14	1 2 RPM		20 Min	CCW
15	1 30 RPM	30 Min		CW
16	1 60 RPM	60 Min		CW
17	1 10 RPM		100 Min	CCW
18	1 2 RPM	120 Min		CW
19	1 15 RPM		150 Min	CCW
20	1 3 RPM	3 Hr		CW
21	1 30 RPM		5 Hr	CCW
22	1 6 RPM	6 Hr		CW
23	1 60 RPM		10 Hr	CCW
24	1 2 RPM		20 Hr	CCW
25	1 3 RPM		30 Hr	CCW
26	1 6 RPM		60 Hr	CCW
27	1 2 4 RPM		24 Hr	CCW

No. of Switches	NUMBER OF CIRCUITS				
	1	2	3	4	5
Dimension "A"	1-9/32 (32.53)	1-25/32 (43.23)	2-9/32 (57.93)	2-25/32 (70.63)	3-9/32 (83.33)
No. of Switches	6	7	8	9	10
Dimension "A"	3-25/32 (96.03)	4-9/32 (108.73)	4-25/32 (121.43)	5-9/32 (134.13)	5-25/32 (146.83)
Dimension "B" Motor Depth	Time Symbols 01 - 05 Maximum - 1-1/2 (38.10) Time Symbols 06 - 25 Maximum - 1-5/8 (41.53)				

For parts list, request Bulletin 345 F

## ORDERING INFORMATION

